

08/2015

Instruction Manual

PowerBox Systems®

World Leaders in RC
Power Supply Systems

COCKPIT COMPETITION SRS



Dear customer,

We are delighted that you have decided to purchase the **PowerBox Cockpit / Competition SRS** from our range.

We hope you have many hours of pleasure and great success with your new **PowerBox**.

1. Product description

The **PowerBox Competition SRS** and **Cockpit SRS** incorporate **SRS** technology, and since their introduction in 2010 they have gained wide acceptance as the current state of technology. SRS stands for **Serial Receiver System**: in contrast to conventional backer systems, the servo information is transferred from the receiver in the form of a digital serial signal. This reduces the physical connection between the receiver and the **PowerBox** to a single cable. It is also straightforwardly possible to connect a second receiver, which takes over the entire control system in full, without any restrictions, if the first receiver should fail.

All the essential components for a secure power supply voltage - ICs, micro-controllers and electronic circuits - are **duplicated**. The outstanding features of this High-End power supply unit are a raft of the latest innovations, **unrestricted channel assignment** (channel-mapping) at the outputs, integral high-resolution **graphic OLED screen**, door sequencer capable of multitasking with Setup Assistant, four match-channels and the facility to bind to the downlink channels of various manufacturers.

Features:

- **SRS: Serial Receiver System** provides the facility to use receivers with serial interface: Spektrum DSM2 and DSMX, Multiplex M-Link, Futaba S-Bus, Graupner HoTT, Jeti R-SAT, JR DMSS.
- Unrestricted channel assignment of the **PowerBox** outputs
- Integral high-resolution graphic OLED screen with 128 x 64 pixels
- Particularly user-friendly menu-based programming using the **SensorSwitch**
- Door sequencer: six freely programmable outputs with set-up assistant
- Channel lock when undercarriage is retracted
- 12 channels inclusive one channel for the doorsequencer in the **Cockpit** Version
- 14 channels in the **Competition** version
- Signal amplification and interference suppression for 12 channels and 21 servos in the **Cockpit** version
- Signal amplification and interference suppression for 14 channels and 18 servos in the **Competition** version
- Synchronised servo output for totally synchronous servo response
- Flight recorder: records Lost Frames and fail-safe periods for all receivers connected to the backer
- Variable frame rate, range 9 ms - 21 ms
- 16-bit processor for fast, high-resolution signal processing
- Four match-channels, each for two servos. Accurate adjustment of all eight servos
- **Double** regulated output voltage for receivers and servos
- Can be connected to Spektrum, Futaba, Jeti, HoTT and Multiplex MSB downlink channel bus systems
- Direct transmission of battery voltages and capacities to the transmitter
- Separate voltage and capacity displays for each battery
- Software-selectable servo voltage: 5.9 V or 7.4 V
- **Minimum value memory** displays any voltage collapses
- Large-area heat-sinks for high regulator power
- Regulator monitor, regulator malfunction indicator
- Support for three battery types: **LiPo, NiMH / NiCd, LiFePo**
- Suppresses any servo feedback currents which might develop
- Can be updated using the **PowerBox USB Interface**

2. Connections, controls

The following illustrations show the essential sockets and controls:

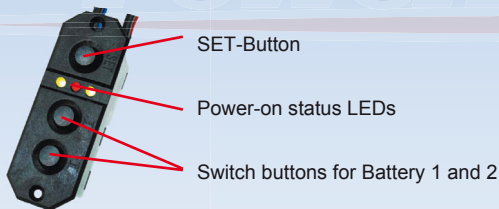
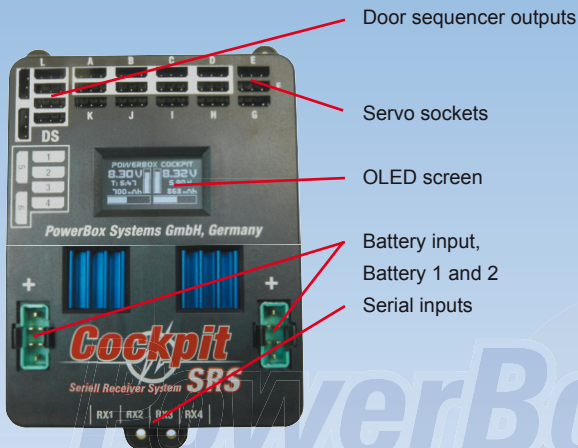

Left: socket for **Spektrum** telemetry
Right: **SensorSwitch** socket



Socket for **USB Interface** and telemetry: **MSB, HoTT and Jeti**

3. First steps, the unit in use:

In the following instructions we do not differentiate between the **PowerBox Cockpit SRS** and **Competition SRS**, since the method of programming the two units is absolutely identical. The only difference is that the **PowerBox Cockpit SRS** includes the **door sequencer** function, whereas the **PowerBox Competition SRS** does not.

3.1. Connections

Plug the batteries into the MPX connectors on the backer with **correct polarity**. We recommend **PowerBox Batteries** of **1500mAh, 2800mAh, 3200 mAh or 4000mAh** capacity. If you prefer to use other makes of battery, or packs you have assembled yourself, please take particular care over polarity - it is always better to check twice rather than make a mistake. If you connect a battery to the backer incorrectly, this will immediately ruin the associated regulator. The unit does not feature reverse polarity protection, as this minimises power losses between battery and backer. The + markings are printed clearly on the case cover.

Connect the **SensorSwitch** to the appropriate red socket. Note that the ribbon cable must run upwards. In models subject to powerful vibration we recommend that you secure the ribbon cable at a minimum of one point in order to prevent the connector working loose and falling out. Although this would have no effect on the switched state of the backer, it would prevent you switching it off.

Do not connect the receiver yet! Please read Point **3.7.** to establish the essential initial settings.

3.2. The procedure for switching on and off

The method of switching the unit on and off is very simple, and the process effectively eliminates the possibility of changing the backer's status accidentally. This is the procedure

Locate the **SET** button on the **SensorSwitch** and hold it pressed in until the central LED glows red. Now press buttons I and II in turn to switch the backer on.

Repeat the procedure to switch off: hold the SET button pressed in, wait until the central LED glows red, then confirm by pressing buttons I and II in turn.

Your **PowerBox** stores the last switched state (on or off). That means: if the backer is switched off using the **SensorSwitch**, it stays switched off.

Once switched on, the backer can only be turned off again using the switch unit. Intermittent contacts or interruptions in the power supply cannot cause the backer to be switched off.

3.3. Main screen display

When switched on, the unit's integral screen shows this display:



Key to the individual display points:

- Digital voltage display:

This extremely accurate display allows you to read off the voltage of the battery directly, i.e. the voltage which is present at the **input** of the **PowerBox**.

- Graphic voltage display:

A brief glance into the model provides you with information about the batteries' state of charge. This display is always correct for the type of battery you have selected. This means that the bar will extend right to the top of the box if the connected battery is fully charged - assuming that you have set the correct battery type. If the bar only fills the bottom third of the box, then the corresponding battery is almost flat. This indicator is supplemented by the residual capacity display.

- Residual battery capacity:

This display shows the momentary capacity value of the battery - again, assuming that you have previously set the battery type correctly. This display is capable of providing very accurate information about the remaining battery capacity, although ageing effects or defective batteries may falsify the value. In practice this means that you should always take both values into account: if the remaining capacity appears to be high, but the voltage has already fallen to a low level, you should consider it an urgent necessity to check the battery more closely.

- Graphic indicator of battery charge state:

This display is set to match the capacity you previously entered for the batteries connected to the backer. Assuming that the battery is of good quality, this means: if the bar only reaches the half-way point, then the battery is still half-full.

- Operating time:

This figure shows the elapsed time since the last RESET. It is important always to carry out a RESET after each battery charge process.

- Output voltage:

This value displays the backer's exact output voltage. The voltage fed to the servos and receiver is the exact value displayed here.

Note:

The residual capacity of the two batteries as displayed on the screen is likely to drift apart as the packs are discharged; this is due to minor differences in the rate of discharge of the batteries through the **PowerBox**. This by no means indicates a fault in the **PowerBox**; in fact it proves that the system features genuine redundancy. Here at **PowerBox Systems** we take great trouble to compensate for manufacturing tolerances between the two regulators, but it is never possible to produce a system which is completely devoid of tolerances. The only method of discharging two batteries at 100% identical rates is to use a system fitted with only one regulator. However, such systems cannot be claimed to offer redundancy!

3.4. After the charge process

The **PowerBox** must be reset after each charge process, otherwise it is impossible for the unit to display reliable values for energy consumption and operating times. This is the reset procedure:

With the system switched on, locate both buttons I and II on the **SensorSwitch** and press them simultaneously; hold them pressed in until the following screen display appears:



3.5. Basic settings

The **PowerBox Cockpit / Competition SRS** feature a new kind of graphic OLED screen, intended to do away with old-fashioned programming methods based on flashing LED codes, morse code beeps or obsolete mechanical jumpers. The screen provides the basis for an extremely user-friendly control system, and eliminates the need for a supplementary setup unit or programming device. The **SensorSwitch** is employed as a convenient means of entering settings within the menu system, and since the **SensorSwitch** is always used as the main ON / OFF switch, it is always installed in the model, so you cannot forget it. Wherever possible the screen provides full information in English; few abbreviations are used. The overall result is an intuitive method of programming which is a great advantage at the flying field, as you will rarely need to consult the operating instructions.

This is the basic rule in programming: buttons I and II are used to move the cursor or **change** values, while the **SET** button is used to select or confirm your inputs.

The breadth of functions offered by the **PowerBox Cockpit / Competition SRS** is enormous, but the unit is by no means difficult to operate. To provide a clear idea of the sequence required in order to use the backer, we have drawn up a brief list of operations

- | | |
|--------------------------------------|----------------|
| 1. Battery setting | Point 3.6 |
| 2. Setting the receiving system | Point 3.7 |
| 4. Output mapping and Failsafe | Point 3.8 |
| 5. Servo matching and door sequencer | Points 4 and 5 |
| 6. Fail-Safe settings | Point 3.9 |

3.6. Battery settings

These settings should always be entered first, so that you have an accurate view of the state of the battery while you carry out further adjustments. In the screenshot below you will see the default settings of the **PowerBox Cockpit / Competition SRS**. If you wish to change them, this is the procedure:

- Switch both batteries on.
- Press the SET button and **hold it pressed** in until the following display appears:

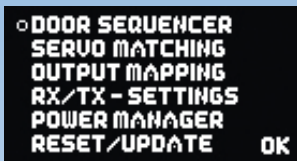

o DOOR SEQUENCER
SERVO MATCHING
OUTPUT MAPPING
RX/TX - SETTINGS
POWER MANAGER
RESET/UPDATE OK

- Press button **II** until the **cursor** (**hollow** circular ring) lines up with **Power Manager**, then press the SET button. The following display now appears:

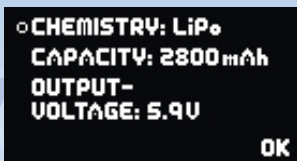

o CHEMISTRY: LiPo
CAPACITY: 2800mAh
OUTPUT-
VOLTAGE: 5.9V
OK

If you wish to change one of the settings, use buttons **I** and **II** to move the cursor to the appropriate menu point, then press the SET button to select it (cursor changes to a solid disc). You can now alter the value using buttons **I** and **II**. Once you have selected the desired value, press the SET button to confirm it; this saves (stores) the new value. Select the menu point **OK** to return to the main menu.

NOTE: the presence of a solid disc (instead of a ring) indicates that you are in a menu point.

It is possible to alter a value more quickly by holding one of the two buttons **I** or **II** pressed in; the value then starts to change slowly in the corresponding direction, and the rate of change accelerates with time.

Key to the individual menu points:

- **Chemistry:**

this is where you set the battery type. Three different types of battery are available:

- Two-cell LiPo
- Five-cell NiMH
- Two-cell LiFe

- **Capacity:**

you can enter the nominal capacity of your batteries at this point.

- **Output voltage:**

you can select the output voltage to 7.4V or 5.9V

CAUTION: if you intend to select the 7.4V output voltage, please ensure **before** you make the change that **all** the consumer units connected to the unit, i.e. **all** servos, receivers and gyros, are compatible with a 7.4V supply. Information on this subject can be found in the instructions for these components supplied by the manufacturers.

Compared with a direct, unregulated voltage of 8.4V, the advantage of a stabilised 7.4V supply is that the voltage is always constant. This means that the servos in your model always run at the same speed and with the same torque, regardless of the manoeuvres you fly. For example, if you were to operate the servos on the unregulated voltage of LiPo batteries, their running characteristics would alter as the freshly charged batteries steadily discharged during the flight. Another major advantage of a regulated 7.4V voltage is that it completely eliminates damaging voltage peaks (spikes); this extends the useful life of the servos substantially.

3.7. Setting the receiver system

Caution:

Please ensure that you have set the correct receiver type **before** connecting the receivers. This is important, because the Spektrum system operates on only **3.3V**, whereas all other receivers work on 5.9V or 7.4V. For example, if you set the receiver system to Futaba and connect a Spektrum Remote Receiver, the Spektrum Remote Receivers will be ruined!

If this setting is not selected, the subsequent functions, settings and assistants only work in a restricted manner.

Switch the **PowerBox** on as described above. Hold the Set button pressed in for a few seconds, and the menu system appears. Select the **RX/TX SETTINGS** point; the first point in the **TX-SYSTEM** menu enables you to select your radio control system:



TX-SYSTEM: DSMX
BIND

FRAMERATE: 12_{ms}
TEACH FAILSAFE

OK

• Spektrum DSM2 and DSMX:

If you select Spektrum DSM2 or DSMX, the additional menu point **BIND** now appears. Whether you select the DSM2 or DSMX option depends on your transmitter type - not on the satellites connected to the system. For example, if your transmitter operates on DSM2, but the satellites are DSMX types, select DSM2 at this point (for example, this applies to all Spektrum modules fitted to MC-24 transmitters).

Now connect your satellites, and select the **BIND** menu point; at least three satellites must be connected. Even if two of three satellites were to fail in flight, **SRS technology** allows the **PowerBox** to continue to function correctly with just a single satellite.

All satellites connected to the system now flash, and can be bound to the transmitter.

The following systems are connected to inputs **RX1** and **RX4** using the three-core patch-leads supplied in the set:

• **Futaba FASST and FASSTEST:**

The **Competition SRS** works with the S-BUS signal. Many receivers require one output to be re-assigned to S-BUS:

- R7003SB: no adjustment necessary; signal present at "PORT 1".
- R7008SB: output 8 must be set to S-BUS, Mode B or Mode D.
- R6303SB: no adjustment necessary; direct S-BUS output fitted
- R6308SB(T): output 8 must be set to S-BUS, Mode B or Mode D.

The S-Bus socket fitted to many Futaba receivers is a potential hazard. The two pictures below illustrate the correct connector position:



Other receivers with an S-BUS output can also be used; please refer to the set-up notes included in the instructions supplied with the receiver.

• **Multiplex M-Link:**

If you are using a Multiplex system, the **B/D** output at the receiver must be set to **Serial Servo Data SRXL**. This can be accomplished using the USB lead and the **MPX Launcher** PC program. If you connect two receivers, the following settings must also be entered: **max. hold duration: 0.2 s** and **max. Failsafe duration: 0.0 s**.

• **SJ HoTT:**

If you wish to use a HoTT receiving system, the **SUMD** signal must be activated at the receiver. Use the SmartBox or the transmitter's Telemetry menu to set **"CH OUT TYPE: SUMD OF 16"**.

"OF" means that the receiver switches the **SUMD** signal off if signal loss occurs. The SRS system detects this within a few milliseconds, and switches over to the second receiver. If you intend to use only one receiver, you can also set **FS** or **HD**.

- **Jeti:**

With a Jeti system it is only necessary to set one **SAT** or **EXT** output (depending on the particular receiver) to **UDI 16**. The remaining adjustments are carried out using the transmitter's device manager:

Serial output: UDI

- **Primary settings:**

- Signal speed: 10 ms
- PPM settings: Direct
- Failsafe: Inactive (if two receivers are in use; otherwise any setting)

- **JR DMSS:**

In the case of the JR DMSS system you must use a receiver with X-Bus output. This is the procedure:

- Connect the Bind plug to receiver 1
- Move to the "SYSTEM LIST" menu at the transmitter, and select "BIND & RANGE"
- Select the "BIND" point, and wait until the LEDs light up green
- Move to the "X-BUS" point in the menu, and select "MODE.A"

If you are using two receivers, disconnect the first one at this point and repeat the procedure with the second receiver. A more detailed description of the procedure can be found in the **Support Forum** on our website.

3.8. Output Mapping

The **OUTPUT MAPPING** function allows the channels to be assigned in any sequence you like. This makes it possible to connect the servos to the sockets which best match the wiring arrangement in your model. The only outputs which have a fixed assignment are those for the door sequencer. By default the outputs have a standard assignment.

Caution: Disconnect the mechanical linkages from the unmatched servos before connecting them to the backer, noting the setup information under Point 4.

```
o A: 15 FS | G: 10 HD
  B:  2 FS | H: 15 FS
  C:  4 FS | I: 12 HD
  D:  3 FS | J:  5 HD
  E:  5 HD | K:  6 FS
  F:  7 HD | L:  9 HD      OK
```

The letters to the left of the colon (:) are the channel outputs, as printed on the case of the **PowerBox Cockpit / Competition SRS**. The numbers to the right of the colon are the channels as they arrive from the transmitter. The **FS** or **HD** to the right of the numbers indicates Fail-Safe or Hold mode. Each channel can be set up individually for the unlikely eventuality of signal loss (when two receivers are in use).

It is now very simple to position the cursor in front of a letter, press the SET button, and assign an input channel to the selected output using the I and II buttons.

If you press the SET button again, you can toggle between **FS** and **HD** using the I and II buttons. Pressing the SET button once more stores the assignment automatically.

It is also a very simple matter to arrange for the same input channel to be present at multiple outputs, if you want more than one output to generate the same function.

Explanation of FS and HD:

- **FS:** If there is a complete loss of signal at all receivers connected to the system, this output runs to a previously determined position. See Point 3.9. for information on defining this position.
- **HD:** If there is a complete loss of signal at all receivers connected to the system, this output remains in the last known valid position.

3.9. Teaching the failsafe positions

Access the **OUTPUT MAPPING** menu and set the appropriate outputs to fail-safe as shown above. Now leave the **OUTPUT MAPPING** menu and select the **RX/TX SETTINGS** menu, where you will find the **TEACH FAILSAFE POSITIONS** menu point.

Use the transmitter to move all the model's control surfaces, the undercarriage and the throttle to the positions which you want them to take up if a fail-safe situation should occur, then press the SET button: this action stores your selected positions.



Check the settings by moving all the functions to any “non fail-safe position” at the transmitter - e.g. move throttle to “full-throttle” - then switch the transmitter off. All the outputs which are marked **FS** in the **OUTPUT MAPPING** menu should now move to the previously set positions, whereas all outputs not marked **FS** remain in the last known position.

Note: thanks to the backer's integral **SRS system**, and the facility to operate two receivers simultaneously, the chances of complete transmission failure are virtually zero. This claim is based on our three years of experience with existing **SRS products**.

4. Servo Match Function

The Servo-Match function provides the facility for adjusting the centre position and end-points of the servos connected to the backer. If you have a model aircraft with more than one servo per control surface, this makes it possible to set up multiple servos to move to identical positions at identical times. Since this ensures that the servos do not work against each other, their effective life is increased, and more power is available to move the control surfaces; matched servos also draw lower current. It is also possible to reverse the direction of rotation of individual servos. This function is useful if you wish to employ fewer channels at the transmitter. For example, the right and left elevators, or the right and left landing flaps, can be controlled using only one radio channel. In models such as jets and warbirds, which by their nature have a large number of working systems, this feature can be very important, but it can also make transmitter programming much easier with other types of model.

Select **SERVO-MATCHING** in the Main menu, and the following screen display appears:



To ensure accurate servo matching, the output to be adjusted must first be initialised. Leave the associated transmitter stick at centre. Move the cursor to **INIT OUTPUT** and press the SET button. Now move the transmitter stick to both end-points.

The graphic display shows the movement of the upper arrow, which indicates the input signal. The bar inside the box shows the movement of the output. The three lower arrows indicate the centre and end-point positions which are 'learned' in this process.

Note: if the channel has not yet been initialised, it is not possible to select the **START SERVOMATCHING** and **REVERSE SERVO** points.

The following examples illustrate the correct procedure for the Servo-Match function:

a) Fine-tuning multiple servos to operate on a single control surface; in this case the aileron of the right-hand wing.

- Disconnect the linkages to the - as yet unmatched - servos, to avoid them being subjected to severe forces during the adjustment procedure.
- Assign the output to the appropriate socket in the **OUTPUT MAPPING** menu.
- Set up one servo (generally the inboard one - **SERVO 1**) in mechanical terms, using the transmitter if necessary; continue adjusting until the centre point and the maximum end-points are exactly as required.
- Now access the Servo-Matching menu and select the servo to be matched. In our example this would be **OUTPUT B** and **SERVO 2**.
- Initialise **OUTPUT B** as described above.
- Move the cursor to **START SERVOMATCHING** → but do not press the SET button at this stage!
- At the transmitter, move the aileron stick to the position to be adjusted, then press the SET button.
- You can now release the aileron stick: the **PowerBox** maintains this position. You now have both hands free, and can adjust the position accurately with one hand, using buttons I and II, whilst checking the length (matching) of the disconnected ball-link at the horn with the other hand.
- Press the SET button again to conclude this adjustment.
- Complete the set-up procedure for the centre position and both end-points before re-connecting the servo linkage.
- If you need to carry out further adjustments to another end-point or centre position, move the aileron stick in the desired direction again, and press the SET button again to start the procedure.
- Repeat the procedure with all the servos connected to the same control surface.

Note: if your model is fitted with very large ailerons, it can be advantageous not to match the servos with 100% accuracy. If the servos are precisely matched, gearbox play may allow aileron flutter to develop. You can eliminate this risk as follows: first match the servos exactly to each other, and then press buttons I or II two or three times to reduce the effect of lost motion in the servo gears to a controlled extent.

b) **Reversing an output when servos are installed in a “mirror-image” arrangement: in this case left and right landing flaps.**

- Disconnect the linkage to the left-hand landing flap, to avoid the servo being subjected to severe forces during the adjustment procedure.
- Assign the output to the appropriate socket in the **OUTPUT MAPPING** menu. In our example: right landing flap to **OUTPUT D, SERVO 1** and left landing flap to **OUTPUT D, SERVO 2**.
- First set up the right-hand landing flap servo in mechanical terms, using the transmitter if necessary; continue adjusting until the centre point and the maximum end-points are exactly as required.
- Now access the Servo-Matching menu and select the servo to be matched (left landing flap **SERVO 2**).
- Move the landing flap switch to the centre position - not one end-point!
- Now select: **INIT OUTPUT**
- The output is initialised by moving the switch on your transmitter to both end-points. If you have set up a delay at the transmitter, wait until the end-point has been reached.
- Use the SET button to select **REVERSE SERVO**. A tick appears after the function, and the left-hand landing flap servo now operates in the correct direction.
- Move the cursor to **START SERVOMATCHING** and press the SET button.
- Use button I or II to adjust the centre position of the left-hand landing flap to the exact position required, then press the SET button.
- Move the transmitter switch to the “flaps extended” position, then press the SET button again.
- Now set the appropriate end-point using button I or II before concluding the procedure with the SET button.
- Move the transmitter switch to the “retracted” position, then press the SET button again.
- Now set the corresponding end-point with button I or II, and conclude the procedure by pressing the SET button.
- Both landing flaps will now move synchronously.

5. Setting up the door sequencer

Select the **SEQUENCER** point at the main menu; this takes you to the following screen display:



The **SETUP ASSISTANT** is a new function in the **Cockpit SRS** which has been included since software version 15; it makes the task of programming the actual door sequencer function considerably easier.

The **EXPERT MENU** provides a very powerful programming interface, with which you can program highly individual sequences, or alternatively expand the settings previously entered using the **SETUP ASSISTANT**.

The **SETUP ASSISTANT** describes the **TASKs** in the actual door sequencer in accordance with the data you enter. The Assistant guides you through the settings: everything you need to do is described on the screen. These printed instructions simply provide additional information which cannot be displayed on the **PowerBox** screen due to size limitations.

The recommended programming procedure is as follows: first enter the basic settings using the **SETUP ASSISTANT**. At this point the system setup will be complete for 90% of all models. If you wish to add more wheel doors or adjust the sequence to cater for other details, this can be carried out in the **EXPERT MENU**.

Select the **SETUP ASSISTANT** in the menu; this takes you to the following screen display:



Operate the appropriate transmitter switch, and the **PowerBox** automatically detects it as the switch which you have assigned to the retract system. The on-screen arrows should now be located in front of **UP/DOWN**. If you find that your retract switch works in the wrong “sense” (direction), correct it by reversing that output at the transmitter. Press the SET button again to proceed.

The door sequencer’s method of working is determined in the following menu:



The following sequences are available:

Mode 1:

Extend undercarriage:

Open wheel doors → extend undercarriage

Retract undercarriage:

Retract undercarriage → close wheel doors

Mode 2:

Extend undercarriage:

Open nosewheel doors → extend nosewheel

Open main wheel doors → extend main undercarriage → close main wheel doors

Retract undercarriage:

Retract nosewheel → Close nosewheel doors

Open main wheel doors → retract main undercarriage → close main wheel doors

Mode 3:

Extend undercarriage:

Open nosewheel doors → extend nosewheel → close nosewheel doors

Open main wheel doors → extend main undercarriage → close main wheel doors

Retract undercarriage:

Open nosewheel doors → retract nosewheel → close nosewheel doors

Open main wheel doors → retract main undercarriage → close main wheel doors

Move the cursor to the appropriate mode, and press the SET button to confirm your choice. Select **OK** to move on to the next screen display:

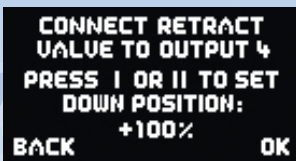

CONNECT RETRACT
VALVE TO OUTPUT 4
PRESS I OR II TO SET
DOWN POSITION:
+100%
BACK OK

Connect your retract system valve to output 4. One of the following will now occur, depending on the way your valve is programmed:

Valve is triggered, and the undercarriage retracts. Press button II on your **SensorSwitch**, and hold it pressed in until the undercarriage extends again.

Valve is not triggered, and the undercarriage remains in the extended state.

Press the SET button twice to move to the next screen display:

**CONNECT RETRACT
VALUE TO OUTPUT 4
PRESS I OR II TO SET
UP POSITION:
+100%
BACK OK**

The undercarriage should now retract. If not, hold **button I** pressed in until the valve is triggered, and the undercarriage retracts. Press the **SET button** to move on to the next stage of the procedure.

**CONNECT FRONT DOOR
TO OUTPUT 1
PRESS I OR II TO SET
CLOSED POSITION:
+100%
BACK OK**

**CONNECT FRONT DOOR
TO OUTPUT 1
PRESS I OR II TO SET
OPENED POSITION:
+100%
BACK OK**

Connect the nosewheel door servo to output 1. Press the **SET button** to close the nosewheel door; repeat the procedure in the next set-up screen to open the door.

The succeeding steps are used to set up the rear wheel doors; the procedure is identical to that described for the nosewheel door. The servo for the right-hand wheel door is connected to output 2, that for the left-hand wheel door to output 3.

**CONNECT RIGHT DOOR
TO OUTPUT 2
PRESS I OR II TO SET
CLOSED POSITION:
+100%
BACK OK**

**CONNECT RIGHT DOOR
TO OUTPUT 2
PRESS I OR II TO SET
OPENED POSITION:
+100%
BACK OK**

**CONNECT LEFT DOOR
TO OUTPUT 3
PRESS I OR II TO SET
CLOSED POSITION:
+100%
BACK OK**

**CONNECT LEFT DOOR
TO OUTPUT 3
PRESS I OR II TO SET
OPENED POSITION:
+100%
BACK OK**

Note: if you are only using one valve for all the wheel doors, you can by-pass the last four points by selecting **OK**.

All the settings are now complete, and you will see one final safety query:

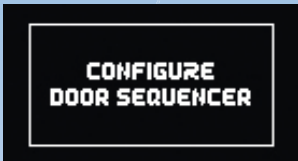

**CONFIGURE
DOOR SEQUENCER**



**SWITCH TO GEAR
DOWN POSITION
OK - PLEASE WAIT**

Move your transmitter switch to the “gear down” position. It will now take a few moments for the Assistant to create the necessary tasks, and move the doors to the correct position without any fouling or jamming. If the timing (pauses, opening times and closing times) is not exactly as you wish, you can change the settings manually at any time.

Select the **EXPERT MENUE** point in the **DOORSEQUENCER** menu, and you will see this screen display:



**○ ACTION: UP => DOWN
TASK: 1 SERVO: -
START-POS: 1500 μS
STOP-POS: 1500 μS
STARTTIME: 0.0 s
STOPTIME: 0.0 s OK**

The **PowerBox** door sequencer is an in-house development which offers unprecedented facilities for the programmed movement of wheel doors. Right at the outset it is important to understand that the system opens up entirely new possibilities.

For example, the sequencer does not constrain you to use pre-set modes, forcing you to adopt fixed, pre-determined vectors for retracting and extending the undercarriage.

The **PowerBox** door sequencer offers innumerable options, because the modeller has the freedom to define each step in terms of travel, sequence and timing. For example, all the wheel doors can be set to open or close at entirely different speeds. It is also possible to set up multiple forward-and-back sequences. If the full-size aircraft features a

“jerk” when the legs lock, that can also be simulated. The opening and closing processes can be set up entirely individually and independently of one another.

In spite of the vast scope of these facilities, the sequencer is simple and user-friendly to set up, as the screen and menu system guide you through the procedure. The sequencer software also features supplementary programming aids. Once you understand the principle, the system can easily be programmed without recourse to the manual.

We always recommend that you start the set-up procedure using the **SETUP ASSISTANT**. This incremental set-up aid creates the tasks required, automatically detects the retract switch channel, and assigns the transmitter channel for the gear switch. If you use the Assistant, but find it necessary or desirable to alter the settings subsequently - perhaps to fine-tune the timing - then this can be carried out using the menu points outlined below. To help you arrive quickly at a satisfactory result, the following section lists the door sequencer functions in detail:

The primary component of the procedure is the **TASK**, which is self-explanatory: a task refers to the movement of a servo from its starting point to its stop point with a defined start and stop time. Twelve tasks are available for the retraction process, and a further twelve for extension. In total 24 different movement sequences can be programmed.

A TASK contains the following information:

Value	Range
Task number	1 - 12
Extend or retract undercarriage	ACTION Up or Down
Servo number	1 - 6
Servo START position	700 μ s - 2300 μ s
Servo STOP position	700 μ s - 2300 μ s
Start time	0 - 25.0s
Stop time	0 - 25.0s

Intelligent programming aid:

If you wish to set up multiple tasks in order to move the wheel doors to several positions, it should be obvious that the new task's initial positional value and start time are determined by the previous position and time for the servo concerned. This is carried out automatically, helping to speed up the programming procedure, and eliminates the need for you to note down the servo's previous position and stop time. A similar situation applies when you set the retract process **DOWN » UP**. When you set up the extend process **UP » DOWN**, the positional values for Start and Stop for that servo are already entered as Stop and Start.

The following example demonstrates how one wheel door opens half-way when the transmitter switch is operated, pauses for a while, then runs to its end-point. When the switch is reversed, the door returns to its original position in a single movement lasting three seconds.

```
o ACTION: UP » DOWN
  TASK: 1      SERVO: 3
  START-POS: 1100 µS
  STOP-POS: 1500 µS
  STARTTIME: 1.0 s
  STOPTIME: 4.0 s OK
```

UP » DOWN means undercarriage extension. Output 3 of the door sequencer has been selected. The servo runs from its initial value of 1100 µs (right servo end-point) to the stop value of 1500 µs (servo centre).

The servo only starts moving 1.0 seconds after the switch is operated, and the period is 3.0 seconds (4.0 s – 1.0 s).

Task 1 has now completed its course.

```
o ACTION: UP » DOWN
  TASK: 2      SERVO: 3
  START-POS: 1500 µS
  STOP-POS: 1800 µS
  STARTTIME: 6.0 s
  STOPTIME: 8.0 s OK
```

After a pause lasting 2.0 seconds at servo centre, the servo starts moving in the direction of 1800 µs (left servo end-point). The movement period is 2.0 seconds (8.0 s – 6.0 s).

Task 2 has completed its course.

```

o ACTION: DOWN ⇒ UP
  TASK: 1      SERVO: 3
  START-POS: 1800 μS
  STOP-POS: 1100 μS
  STARTTIME: 0.0 s
  STOPTIME: 3.0 s OK

```

DOWN » UP means undercarriage retraction. In this example, when the switch is operated, the servo immediately starts running slowly from the left to the right servo end-point (Start time 0.0 s).

The positional values vary according to your linkages, and must be adjusted to suit your individual model. Clearly it is important to avoid your wheel doors jamming (striking their mechanical end-stops). The timing values shown here should also be set to suit your requirements. The task numbering does not need to coincide with the timed sequence; for example, **TASK 5** could be set to run before **TASK 2**.

Our example clearly shows how the function is built up. Additional movements or intermediate stops when the doors open or close can be added at any time; all you need is to set up a new free task. Viewed overall, there is now no reason at all why the retraction and extension of the undercarriage in the model should not exactly emulate that of the full-size aircraft. In other words: you can give free rein to your imagination.

Note: if you wish simply to switch servos or valves on or off, you must always enter a time difference in the sequence, as the door sequencer needs a small amount of time to carry out its calculations. The following is an example for a retract valve:

```

o ACTION: DOWN ⇒ UP
  TASK: 1      SERVO: 1
  START-POS: 1900 μS
  STOP-POS: 1100 μS
  STARTTIME: 0.0 s
  STOPTIME: 0.1 s OK

```

```

o ACTION: UP ⇒ DOWN
  TASK: 1      SERVO: 1
  START-POS: 1100 μS
  STOP-POS: 1900 μS
  STARTTIME: 0.0 s
  STOPTIME: 0.1 s OK

```

The time lag of 0.1 s is sufficient, and is virtually unnoticeable in practice.

Important: the first **START POSITION** at **UP » DOWN** must always coincide exactly with the last **STOP POSITION** of **DOWN » UP**. This simply means that the last task must cause the servo to return to its starting value, regardless of any individual intermediate steps you create! If the wheel door servos carry out unusual or unexpected movements when you try out the programmed sequence, please check your tasks!

6. Channel lock when undercarriage is retracted

The **PowerBox Cockpit SRS**'s door sequencer also features one last unique function: it is now possible to switch a channel off when the undercarriage is retracted. The purpose of this feature is to prevent the retracted nosewheel moving inside the fuselage when the pilot gives a rudder command, as this may cause the mechanical system to jam. The function can be found under **GEAR UP - OUTPUT OFF** in the Door Sequencer menu. Simply use the SensorSwitch to select the output which you wish to disable when the undercarriage is retracted. Select the output, and confirm your choice with the SET button; at the same time the system stores the position of the nosewheel servo at which it is to remain.

7. Reading out the flight recorder

The **RF-Flight Recorder** display is accessed by briefly and simultaneously pressing **buttons I** and **II** on the **SensorSwitch**:

RF - FLIGHTRECORDER	
ANT. FADES	LOST
RX 1: 45	FRAMES:
RX2:	-
RX3:	
RX4: 34	HOLDS: -

Antenna Fades:

- Spektrum, Futaba, M-Link: This item displays the lost data packets for the individual receivers
- HoTT and Jeti: This item displays the number of switching events between the receivers

Lost Frames:

This value shows how many occasions none of the connected receivers was able to supply a valid data packet.

Holds:

This value is incremented when none of the connected receivers is able to supply a valid signal for a period longer than 250 ms. When this occurs, the servos move to the Hold or Fail-Safe positions stored in the backer.

8. Frame rate:

What does 'frame rate' mean?

This value indicates the time interval at which the servo signal is refreshed. Modern digital servos are unlikely to encounter problems with the 12 ms setting, but older analogue servos may require a longer setting of 21 ms. For more information on servo compatibility please contact the manufacturer of your servos. A faster refresh rate causes the servos to respond more swiftly, and they will offer greater effective torque because they are capable of counteracting the forces acting upon them more quickly.

Caution:

The Frame-Rate setting should only be changed if you are certain that your servos are designed for the Frame-Rate you wish to use. In the extreme case please note that the servo may lose its triggering, and become "soft".

9. Telemetry

The **Cockpit/Competition SRS** makes battery data available as telemetry information which can be exploited by various makes of radio control system. The unit supports the following makes of equipment, and other systems will gradually be introduced as updates become available:

- Multiplex MSB

Connect the backer's telemetry output to the receiver's sensor input using a standard commercial Uni patch-lead. The voltage and residual capacity of both batteries are now available at the transmitter.

- Spektrum

Connect the four-pin Spektrum Telemetry output to the TM1000, and at the same time bind the TM1000 and the connected satellites to the transmitter. Activate the **PowerBox** Telemetry display at your transmitter. The voltage and residual capacity of both batteries are now available at the transmitter.

The matching X-Bus lead for this can be obtained in various lengths from Horizon Hobby:

SPMA9579	X-Bus extension 150 mm
SPMA9580	X-Bus extension 300 mm
SPMA9581	X-Bus extension 600 mm

- HoTT

Connect the backer's telemetry output to the receiver's Sensor input using a standard commercial Uni patch-lead. Select the "Electric Air Module" in your transmitter's telemetry menu. The voltage of both batteries, and the residual capacity of the weaker battery, can now be viewed on the transmitter's screen.

- Jeti

Connect the backer's telemetry output to the receiver's **EXT** input using a standard commercial Uni patch-lead. The voltage, residual capacity and receiver data are now available at the transmitter.

10. Reset, Update, Save und Restore

The **Cockpit/Competition SRS** offers numerous facilities for resetting individual ranges without affecting other settings. For example, it is possible to reset **Output Mapping** without affecting the **Servo Matching** settings.

All the Reset options can be found in the **RESET/UPDATE** menu:

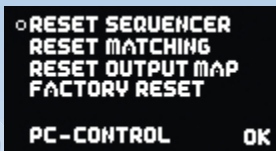

In the interests of safety, the software generates a confirmation query when you select one of the Reset options; the intention is to avoid accidental erasure of data. If you confirm this query, the settings are permanently erased, and cannot be restored.

The lowest line in the menu - **PC-CONTROL** - has several functions: selecting this point enables you to update the software in conjunction with the **PowerBox Terminal PC program**, save the backer's internal settings on a PC, or restore saved settings from a PC.

These options require the installation of **PowerBox Terminal** on your home computer. The PC program is available as a free download from our website, together with installation instructions.

Start the **PowerBox Terminal** program, and look for **UPDATE** and **SAVE/RESTORE** in the top row of tabs. Make your selection, connect the **PowerBox USB Interface** to the **TELEMETRY** socket on the **Cockpit SRS** and select the **PC-CONTROL** point in the menu.

From this point on simply follow the instructions on the screen.

11. Regulator error message

The **PowerBox Cockpit/Competition SRS** constantly checks both voltage regulators independently of each other. If a fault should occur in one of these regulators, this warning will appear on the screen:



There are three possible causes for this warning:

- One or both regulators is generating insufficient output voltage or none at all. This could mean that you are flying with only one regulator functioning, and for reasons of safety this is not permissible.
- One or both regulators is not functioning, and is passing through the full battery voltage. This means that the servos and receiver are being operated on an excessive voltage, which could lead to failures in the longer term. This malfunction usually occurs after a reversed polarity connection.
- One battery is plugged in but not switched on. The second battery is plugged in and switched on. The screen displays the message **REGULATOR MALFUNCTION**. This does not indicate a fault! The message is a warning, and is intended to remind the user to switch on both regulator circuits.

In the first two cases please send the device to our Service Department at the address below, with the completed repair form which you can download from our website.

Service address:

PowerBox-Systems GmbH

**Ludwig-Auer-Straße 5
D-86609 Donauwoerth
Germany**

12. Specification

Operating voltage:	4.0 Volt to 9.0 Volt
Power supply:	2 x two-cell LiPo battery, 7.4 Volt 2 x five-cell NiCd / NiMH batteries, 2 x two-cell LiFePo batteries (A123)
Current drain:	switched on - approx. 125 mA switched off - approx. 33 μ A
Dropout voltage:	approx. 0.25 V
Max. receiver and servo current:	2 x 10 A (stabilised) according to cooling Peak 2 x 20 A
Servo signal resolution:	0.5 μ s
Signal repeat rate: (frame rate)	9ms, 12ms, 15ms, 18ms, 21ms
Screen:	OLED 128 x 64 pixels, graphic
Servo sockets:	Competition: 18 sockets, 14 channels Cockpit: 21 sockets, 12 channels
Temperature range:	-30°C to +75°C
Weight:	115 g
SensorSwitch:	15 g
EMV approval:	EN 55014-1:2006
CE approval:	2004/108/EG
WEEE Reg. No.:	DE 639 766 11

This battery backer fulfils the EMV protective requirements, EN 55014-1:2006 with certificate dated 10 February 2009. EMC approval 2004/108/EG.

The unit must not be connected to a mains PSU!

The **PowerBox Cockpit/Competition SRS** is intended exclusively for use in modelling applications. It is prohibited to use it for any purpose other than in radio-controlled models.

13. Dimensions:

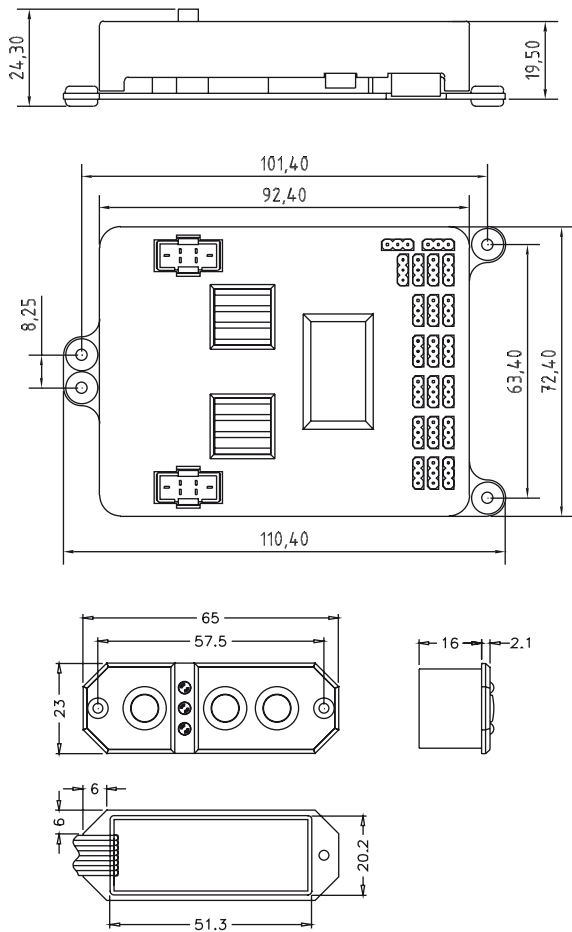

14. Set contents

- **PowerBox Cockpit / Competition SRS**
- 2 patch-leads
- **SensorSwitch**
- 4 rubber grommets and brass spacer sleeves, factory-fitted
- 4 retaining screws
- Operating instructions

15. Service Note

We make every effort to provide a good service to our customers, and have now established a **Support Forum** which covers all queries relating to our products. This helps us considerably, as we no longer have to answer frequently asked questions again and again. At the same time it gives you the opportunity to obtain assistance all round the clock, and even at weekends. The answers come from the **PowerBox team**, which guarantees that the answers are correct.

Please use the Support Forum **before** you contact us by telephone.

You will find the forum at the following address:

www.forum.powerbox-systems.com

16. Guarantee conditions

We take the maintenance of the highest quality standards very seriously, and that is why **PowerBox Systems GmbH** is currently the only RC electronics manufacturer which has been awarded certification to the **DIN EN ISO 9001:2008** industrial norm.

Our stringent quality management, which applies both to development and production, is the reason why we are able to grant a **36 month** guarantee on our products, valid from the initial date of purchase. The guarantee covers proven material faults, which will be corrected by us at no charge to you.

Any repairs carried out during the guarantee period do not extend that period. Claims under guarantee are invalid if damage is due to mishandling or incorrect use, e.g. reversed polarity, excessive voltage or damp. The same applies to defects caused by heavy wear or excessive vibration. Any further claims, e.g. for consequent damages, will not be entertained.

PowerBox

17. Liability exclusion

We are not in a position to ensure that you install and operate this battery backer correctly, nor that you maintain the entire radio control system properly.

Regardless of the legal argument employed, our obligation to pay compensation is limited to the invoice price for those of our products which are involved in the event, unless this restriction is deemed unlawful.

For this reason we are unable to accept liability for loss, damages or costs which result from the use of the device, or are connected with its use in any way!

We wish you every success using your new power supply from **PowerBox Systems!**

A handwritten signature in brown ink, appearing to read 'E. Altmann', is written over a large, semi-transparent watermark of the word 'Systems' in blue. The signature is fluid and cursive.

Donauwörth, August 2015



PowerBox Systems[®]

*World Leaders in RC
Power Supply Systems*

PowerBox-Systems GmbH

certificated according to DIN EN ISO 9001:2008

Ludwig-Auer-Straße 5

D-86609 Donauwörth

Germany

Tel: +49-906-22 55 9

Fax: +49-906-22 45 9

info@PowerBox-Systems.com

www.PowerBox-Systems.com